

C-LP32

Colección C

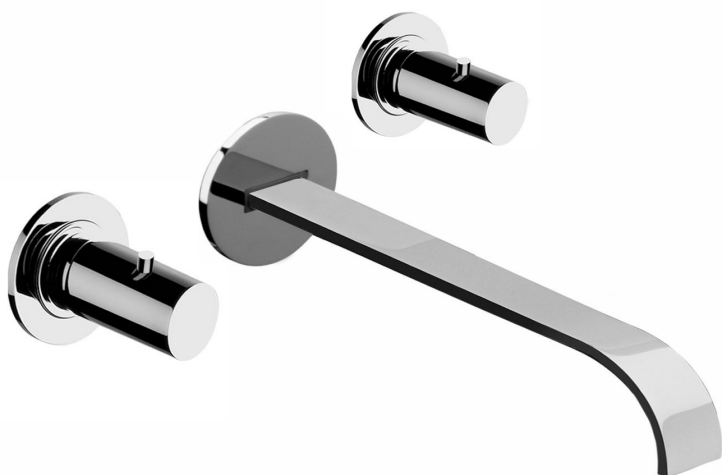

DESCRIPCIÓN

Mezclador doble mando a pared con caño de 212 mm.

Fabricado en latón.

COMPONENTES

- Cartucho cerámico.
- Rosca de cuerpo empotrado 1/2".
- Partes internas del mezclador con mando: C-LP32-UP.
- Set completo con caño de 150 mm., y arandelas: C-LP32-AP.

CAUDAL

3.0 bar

5 l/min

DISPONIBLES REDUCTORES DE CAUDAL BREEAM®



- 3 l/min
- 4 l/min
- 6 l/min

AG 1 CONSUMO DE AGUA
REDUCTORES DE CAUDAL
Y AIREADORES.
Nota técnica NT17

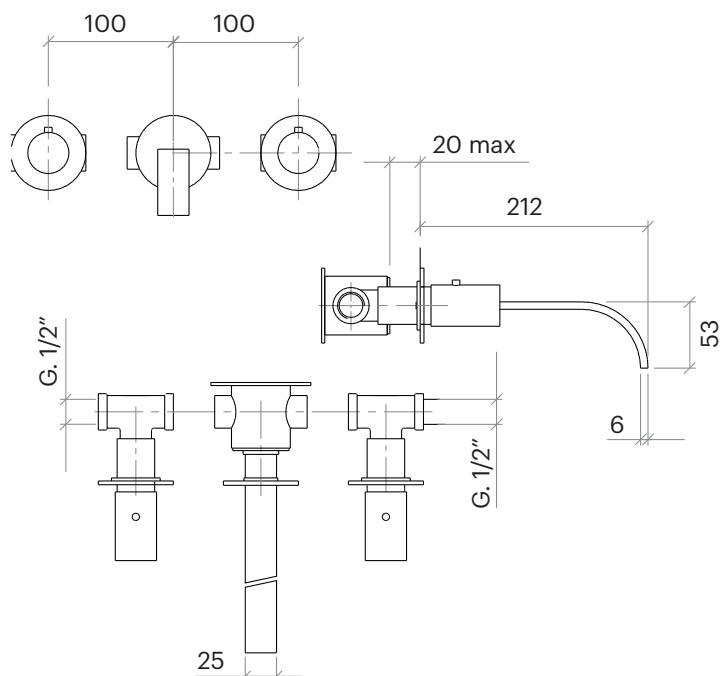
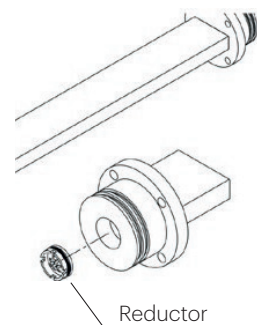

ACABADOS DISPONIBLES

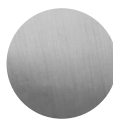
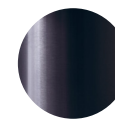

Cromo

Negro
mateBlanco
mateNíquel
cepilladoOro
cepillado

Gunmetal

C-LP32

Colección C

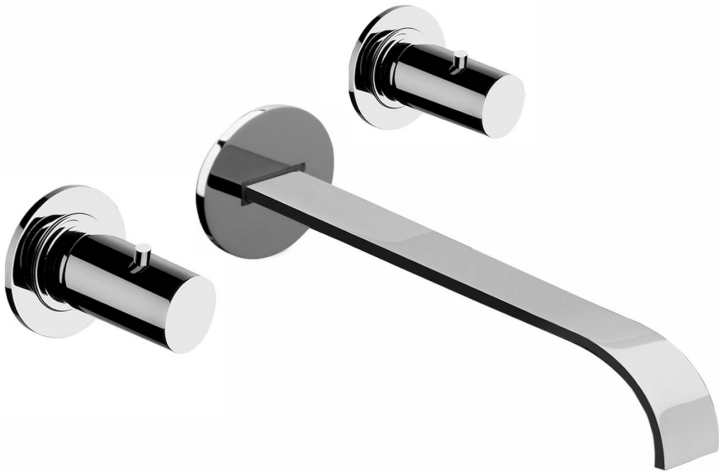

DESCRIPTION

Double wall-mounted faucet mixer with 212 mm spout.

Made of brass.

COMPONENTS

- Ceramic cartridge.
- 1/2" recessed body thread.
- Internal parts of the mixer with command: C-LP32-UP.
- Complete set with spout 150 mm and washers: C-LP32-AP.

FLOW RATE

3.0 bar 5 l/min

AVAILABLE FLOW REDUCERS

- 3 l/min
- 4 l/min
- 6 l/min

BREEAM®



AG 1 WATER CONSUMPTION REDUCERS FLOW AND AERATORS. Tech Note NT17

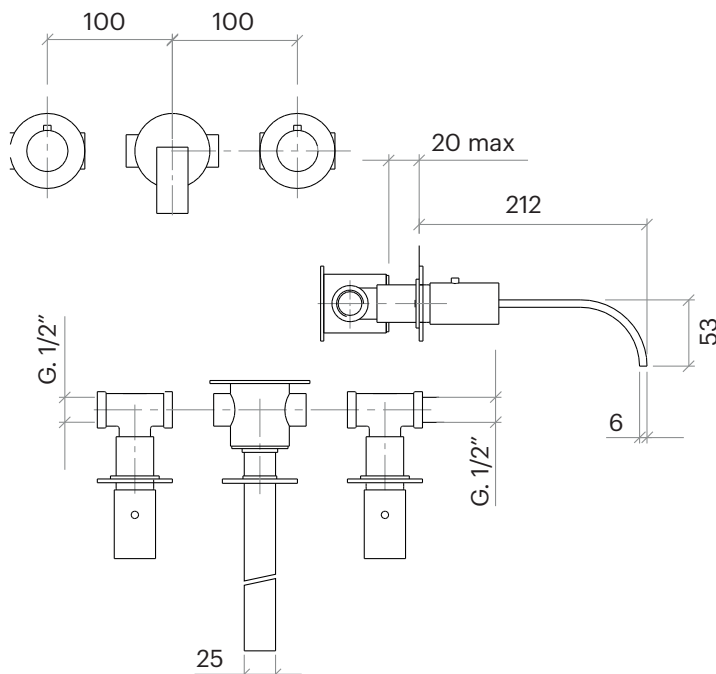
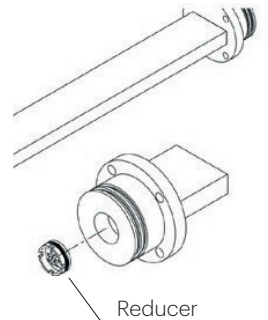

AVAILABLE FINISHES



Chrome



Matt black



Matt white

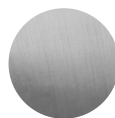

Brushed nickel



Brushed gold

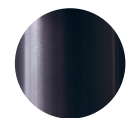

Gunmetal

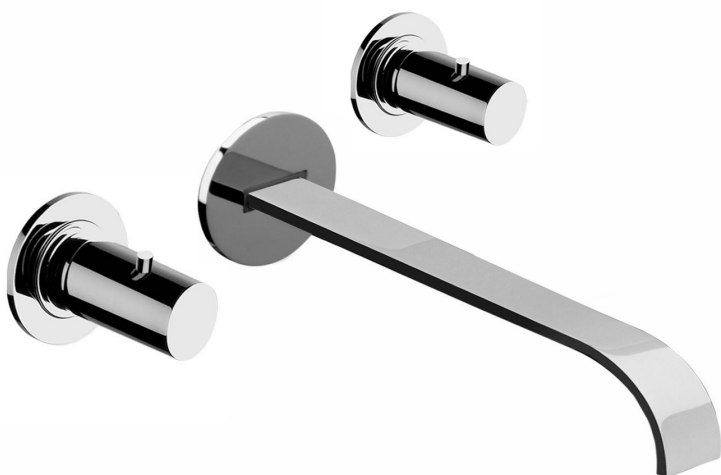
**DESCRIPTION**

Mitigeur double commande au mur avec 212 mm bec.

Fabriqué en laiton.

COMPOSANTS

- Cartouche en céramique.
- Filetage du corps encastré 1/2".
- Parties internes du mélangeur avec télécommande: C-LP32-UP.
- Ensemble complet avec bec de 150 mm., et rondelles: C-LP32-AP.

DÉBITS

3.0 bar

5 l/min

RÉDUCTEURS DE DÉBIT DISPONIBLES**BREEAM®**

- 3 l/min
- 4 l/min
- 6 l/min

AG 1 CONSOMMATION D'EAU
RÉDUCTEUR DE DÉBIT
ET AÉRATEURS.
Tech Note NT17

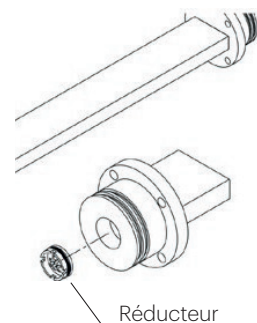

Réducteur

FINITIONS DISPONIBLES

Chrome

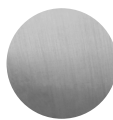
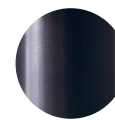
Noir
matBlanc
matNickel
brosséOr
brossé

Canon fusil

