



DESCRIPCIÓN

Lavabo rectangular con las esquinas en ángulo recto, sin rebosadero.

Fabricado en Solid Surface.

CARACTERÍSTICAS

Dimensiones: 800x450x100 mm.

- Instalación sobre encimera o a pared*.
- Modelo de válvula de desagüe con la tapa circular en Solid Surface del mismo color que el lavabo (no incluida por defecto).
- Posibilidad de instalar la grifería en el mismo lavabo (orificios a definir).

PRODUCTOS RELACIONADOS

LB-VALVSOLID: Válvula con tapa para lavabo, de solid surface.

OTRAS MEDIDAS DISPONIBLES

Disponible en las siguientes medidas:

LB26R60G: 600x450x100 mm.

LB26R100G: 1000x450x100 mm.

LB26R120G: 1200x450x100 mm.

ACABADOS DISPONIBLES



Blanco
mate



Color
RAL

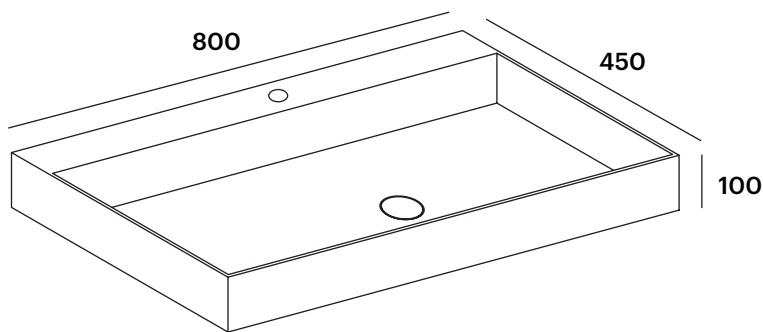

Dimensiones en mm.

*Instalación mediante anclajes mecánicos a pared.

Made in EU



DESCRIPTION

Rectangular washbasin with straight-angled corners, without overflow.

Made of Solid Surface.

FEATURES

Dimensions: 800x450x100 mm.

- Countertop or wall-mounted installation*.
- Drain valve model with circular cover of Solid Surface in the same colour as the washbasin (not included by default).
- Possibility of installing the faucet in the washbasin (holes to be defined).

RELATED PRODUCTS

LB-VALVSOLID: Valve with cover, for solid surface basin.

OTHER SIZES DIMENSIONS

Available in the following dimensions:

LB26R60G: 600x450x100 mm.

LB26R100G: 1000x450x100 mm.

LB26R120G: 1200x450x100 mm.

AVAILABLE FINISHES



Matt
White



RAL
Colour

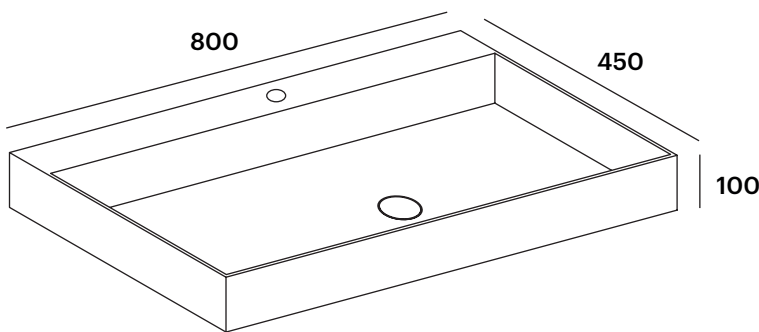

Dimensions in mm.

*Installation through mechanical anchors to the wall.

Made in EU



DESCRIPTION

Vasque rectangulaire avec angles droits, sans trop-plein.

Fabriqué en Solid Surface.

CARACTÉRISTIQUES

Dimensions: 800x450x100 mm.

- Installation du plan de travail ou murale*.
- Modèle de bonde de drainage avec couvercle circulaire en Solid Surface dans la même couleur de la vasque (non inclus par défaut).
- Possibilité d'installer le robinet dans le vasque (perçement à définir).

PRODUITS ASSOCIÉS

LB-VALVSOLID: Bonde avec couvercle, pour vasque.

AUTRES DIMENSIONS DISPONIBLES

Disponible dans les dimensions suivantes:

LB26R60G: 600x450x100 mm.

LB26R100G: 1000x450x100 mm.

LB26R120G: 1200x450x100 mm.

FINITIONS DISPONIBLES



Blanc
mat



Couleur
RAL

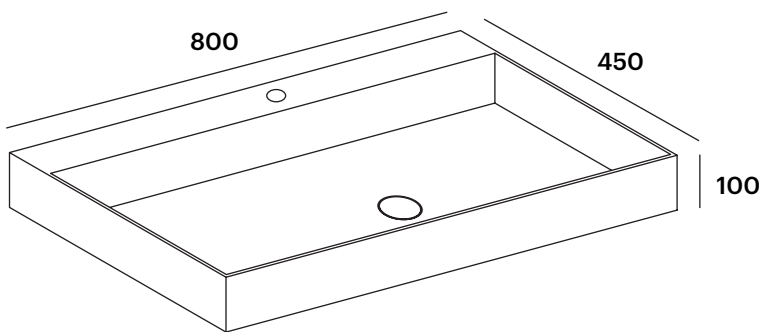

Dimensions en mm.

*Installation à l'aide d'ancrages mécaniques au mur.

Made in EU