



DESCRIPCIÓN

Lavabo circular suspendido sin rebosadero con base trasera y sistema oculto para fijación a pared incluido.

Fabricado en Solid Surface.

- Válvula de desagüe no incluida.
- Modelo de válvula compatible: V64SS.
- Incluye los anclajes para la fijación al soporte.

CARACTERÍSTICAS

Dimensiones	Ø315 x 115 mm
Volumen	0,21 m ³
Peso	4,5 kg

PRODUCTOS RELACIONADOS

LR1S: Instalación mural, sobre encimera o encastrada.

SLS: Instrucciones de montaje del soporte.

ACABADOS DISPONIBLES



Blanco
mate



Color
RAL

- Coloreable según el sistema RAL Classic.
- Color aplicable en el interior, el exterior o ambas superficies.

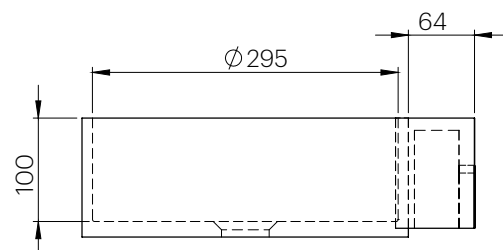
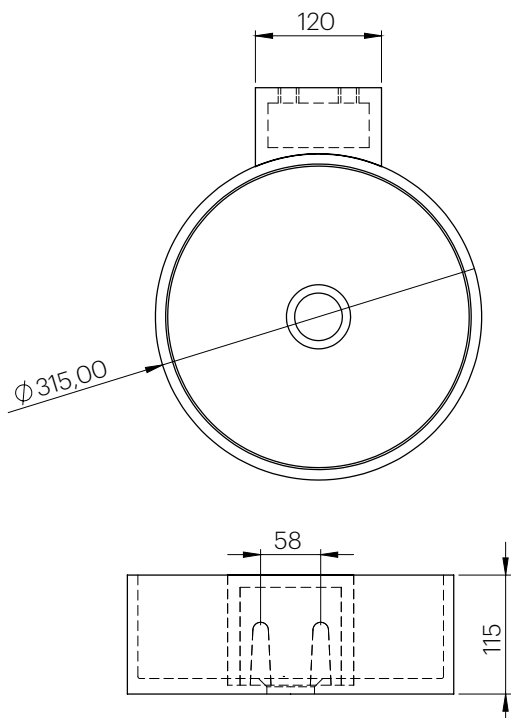



DESCRIPTION

Suspended circular basin without overflow with rear base and concealed system for wall mounting included.

Made of Solid Surface.

- Drain valve not included.
- Compatible valve model: V64SS.
- Includes anchors for fixing to the support.

FEATURES

Dimensions	Ø315 x 115 mm
Volume	0,21 m ³
Weight	4,5 kg

RELATED PRODUCTS

LR1S: Wall-mounted, on-top or recessed installation.

SLS: Mounting instructions for the support.

AVAILABLE FINISHES



Matt
white



RAL
Colour

- Colored according to RAL Classic system.
- Color applicable on the interior, exterior or both surfaces.

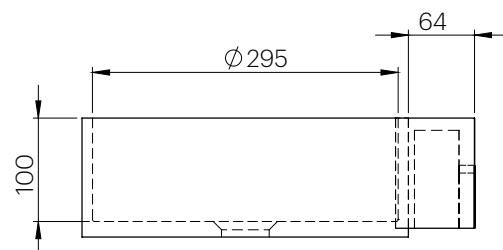
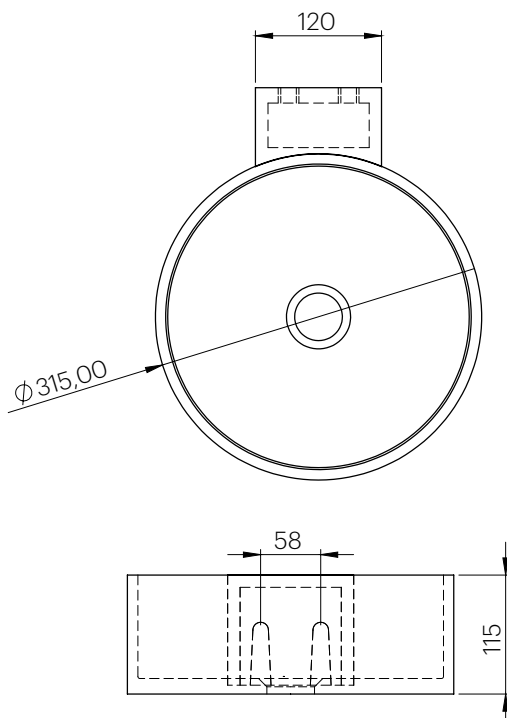



DESCRIPTION

Vasque circulaire suspendu sans trop-plein avec fond arrière et système de fixation invisible inclus.

Fabriquée en Solid Surface.

- Bonde de drainage non incluse.
- Modèle de bonde compatible: V64SS.
- Il comprend les ancrages pour la fixation au support.

CHARACTÉRISTIQUES

Dimensions	Ø315 x 115 mm
Volume	0,21 m ³
Poids	4,5 kg

PRODUITS ASSOCIÉS

LR1S: Installation murale, à poser ou encastrée.

SLS: Instructions de montage du support.

FINITIONS DISPONIBLES



Blanc
mat



Couleur
RAL

- Coloris selon le système RAL Classique.
- Couleur applicable pour les surfaces intérieures, extérieures ou les deux.

